

Chapter 1. Disassembly & Assembly Guide

1-3. Disassembly & Assembly

- Main Section -

MS-1 Main Section Disassembly

Except 1seg Tuner / Wireless WAN Model  [MA]

Battery Pack

1)

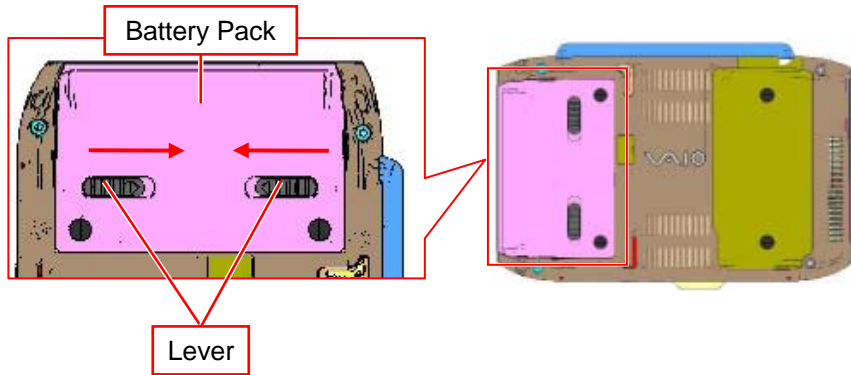

Turn over the main unit, and slide the lever in the direction of the arrow to release the lock.

2)

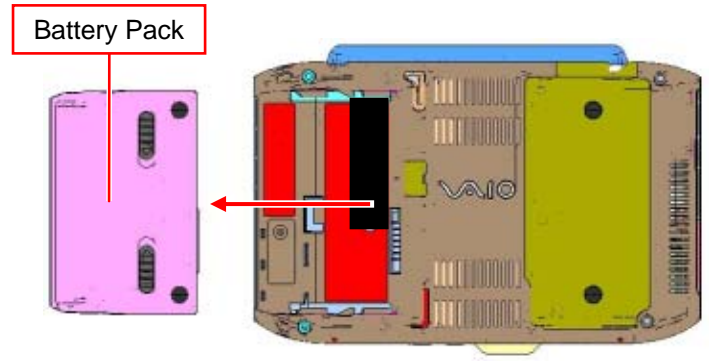

In the state of 1), remove the Battery Pack in the direction of the arrow.

Cap (Stick Pointer) ⚠ [MA]

1)

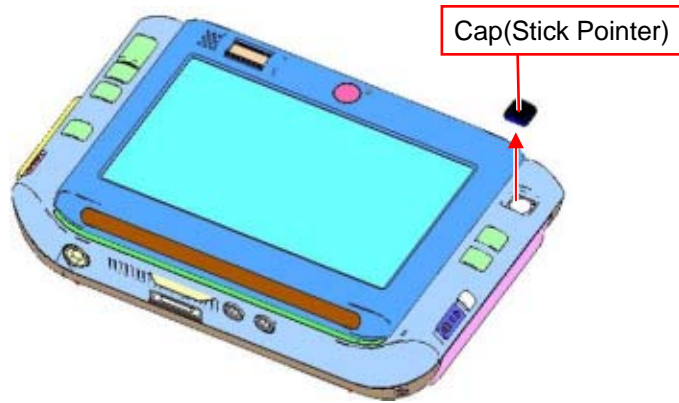

Remove the Cap.

Remark

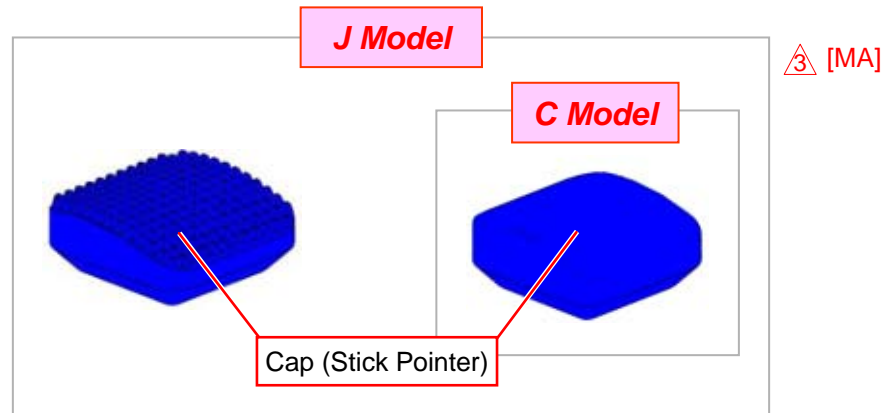

Shape of the Cap

* There are two kinds of Cap for J Model.

When replacing the Cap, be sure to use the Cap of the same shape and color as one used in the repair set.

Dummy Card, Stylus

1)

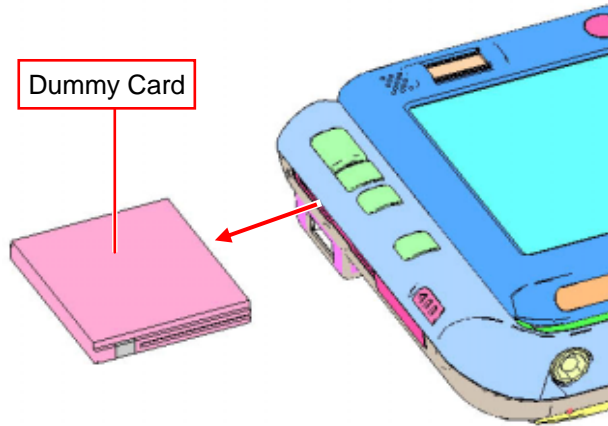

Remove the Dummy Card.

2)

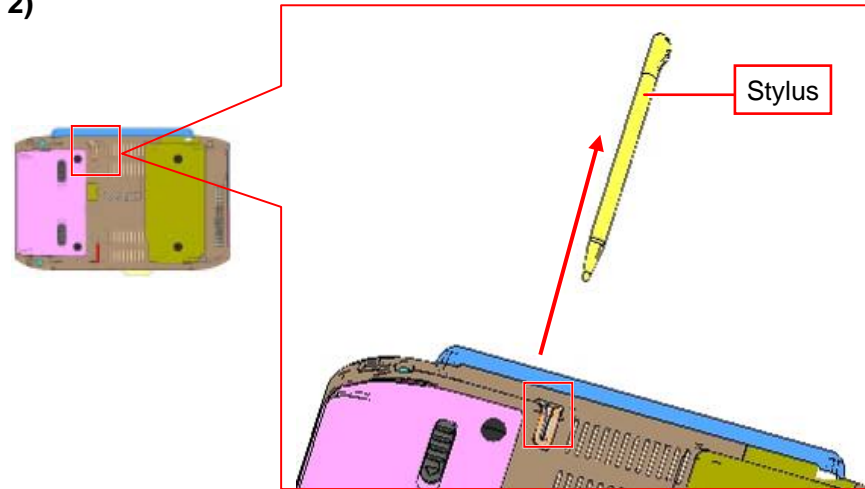

Turn over the main unit and remove the Stylus.

Housing (Bottom)

1)

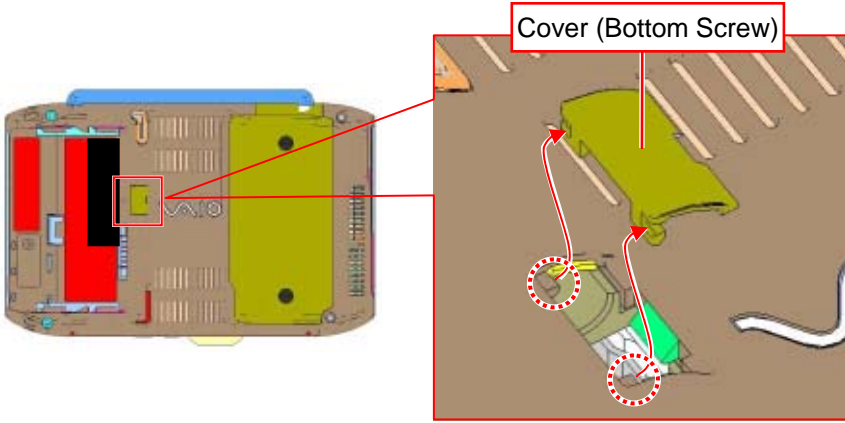

While disengaging the detent (two places), remove the Cover.

2)

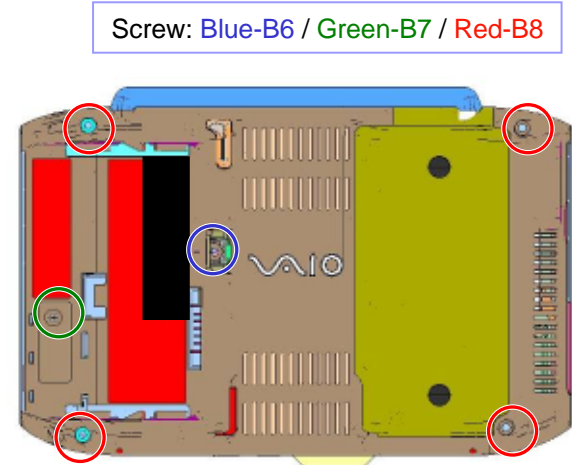

Remove the six screws.

3)

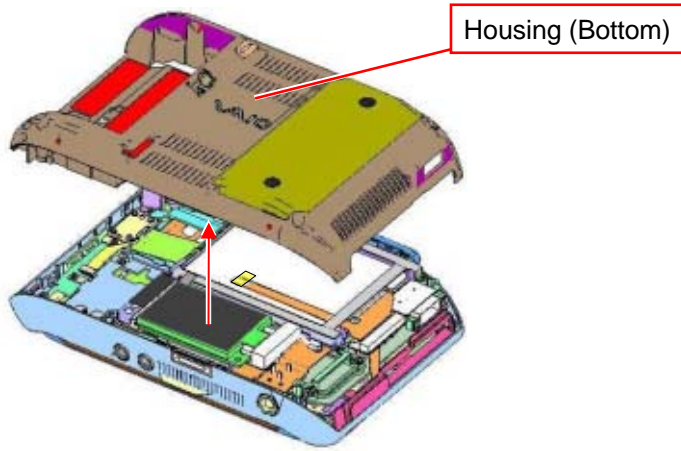

Remove the Housing.

Parts of the Housing (Bottom)

1)

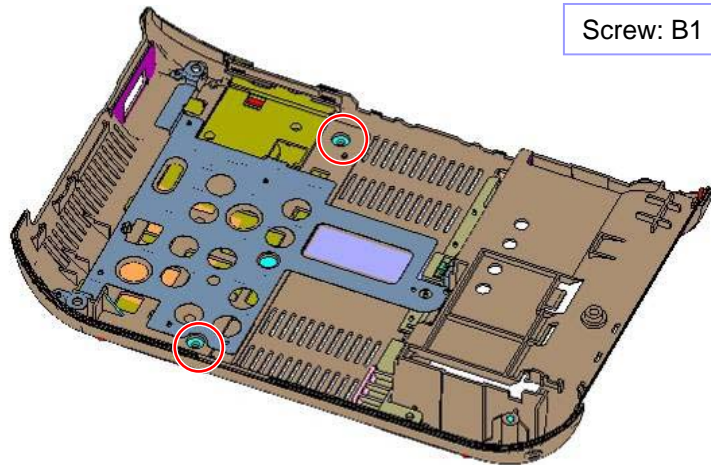

Remove the two screws.

2)

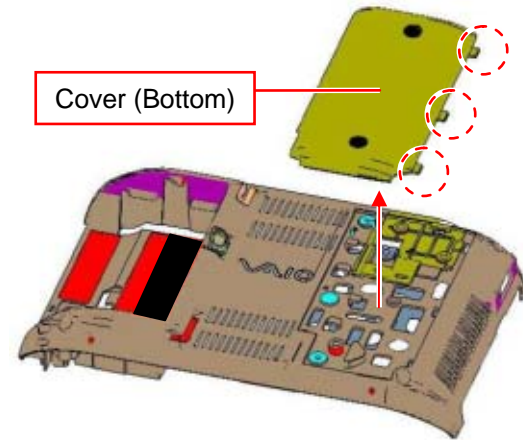

While disengaging the detent (three places), remove the Cover.

3) ⚠ [ADD]

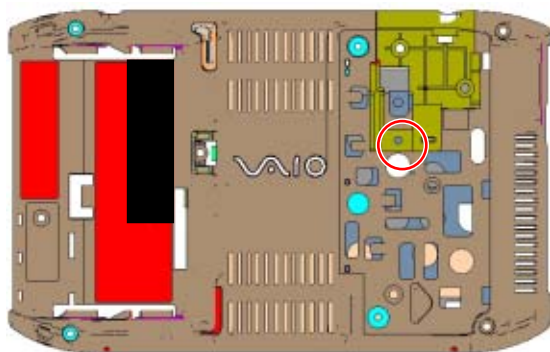

Remove the one screw.

Attachment

1)

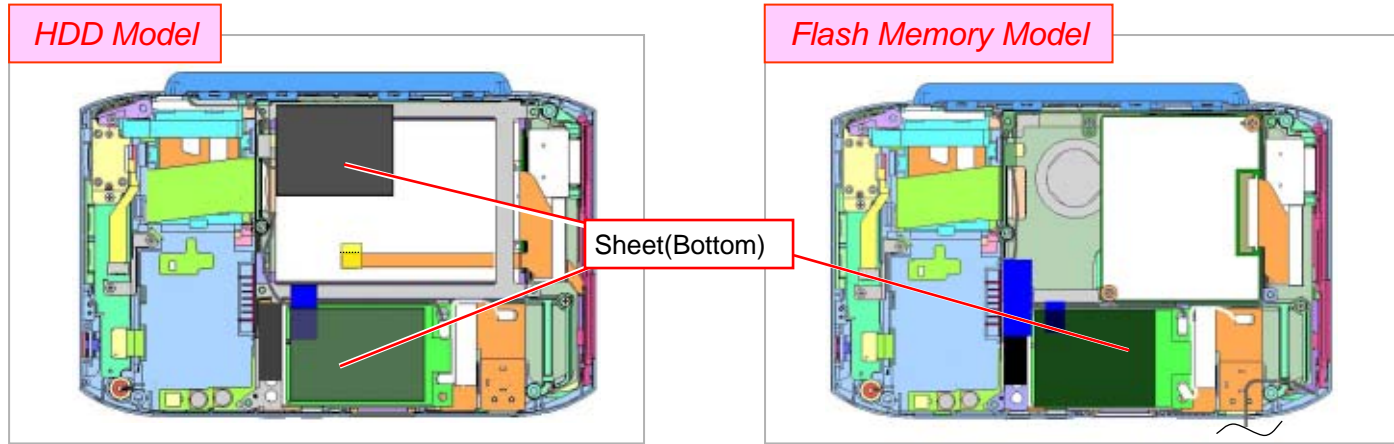

Peel off the Sheet.

*HDD Model - Two places

Flash Memory Model - One place

2)

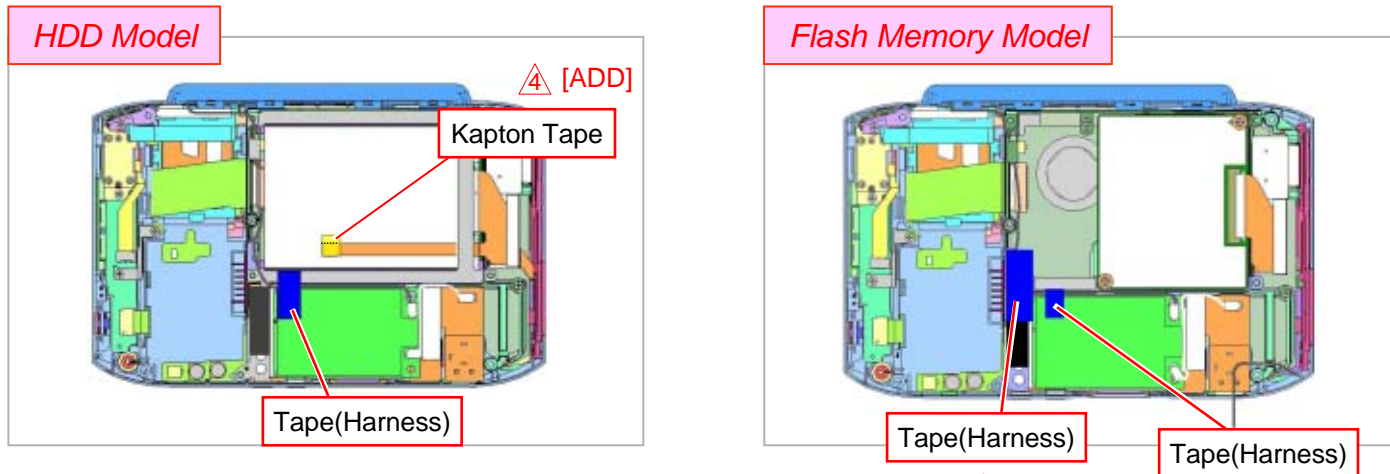

Peel off the Tape.

*HDD Model - Tape (one place), Kapton Tape(One place)

Flash Memory Model -Tape (Two places)

Wireless LAN Card

1)

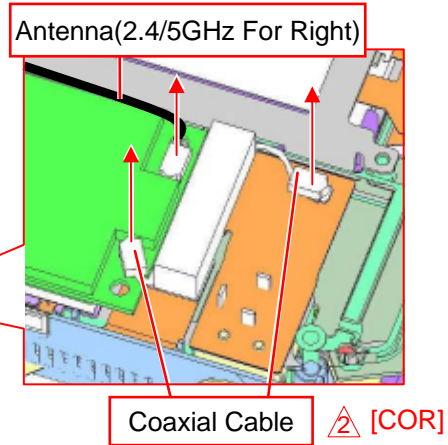

Disconnect the Antenna (one place) and the terminal of the Coaxial Cable (two places) **vertically**.

2)

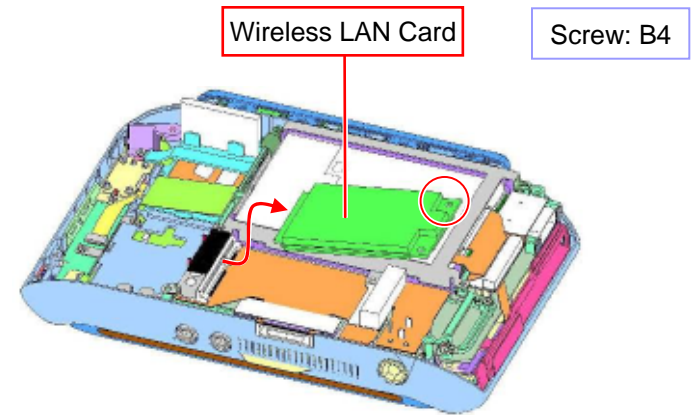

Remove the one screw and then the Wireless LAN Card.

⚠ [MA]

HDD

HDD Model

1)

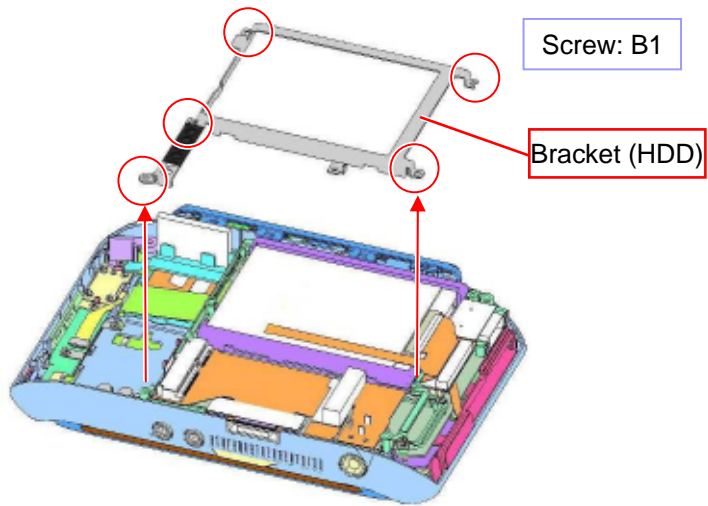

Remove the five screws and the Bracket.

2)

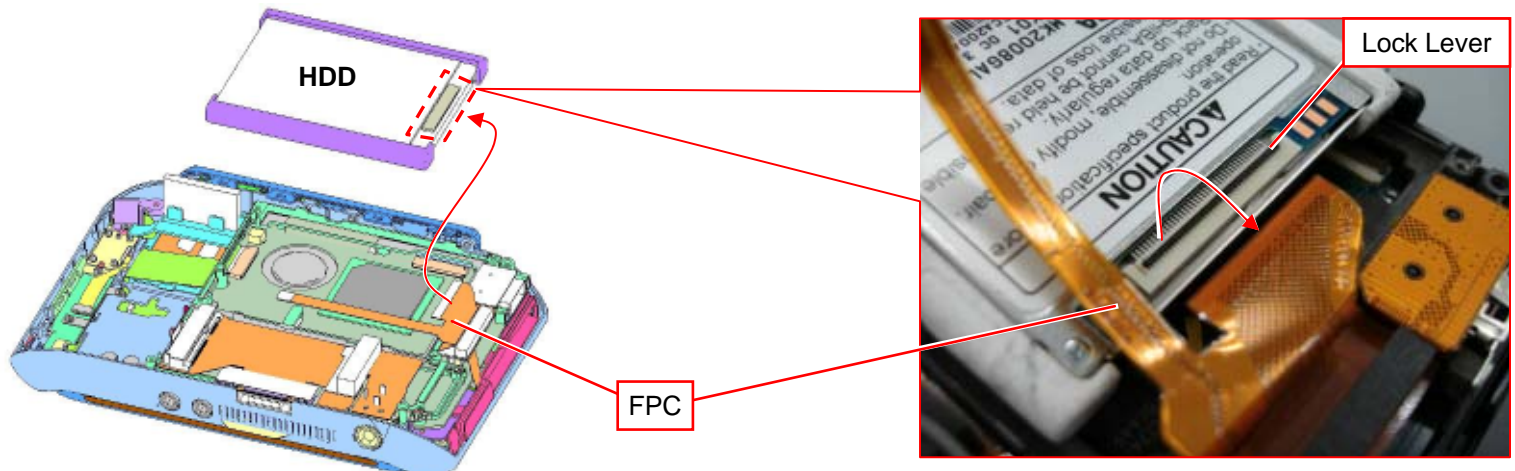

1. Raise the lock lever and release the lock.
2. While disconnecting the FPC, remove the HDD.

Parts of the HDD

HDD Model

1)

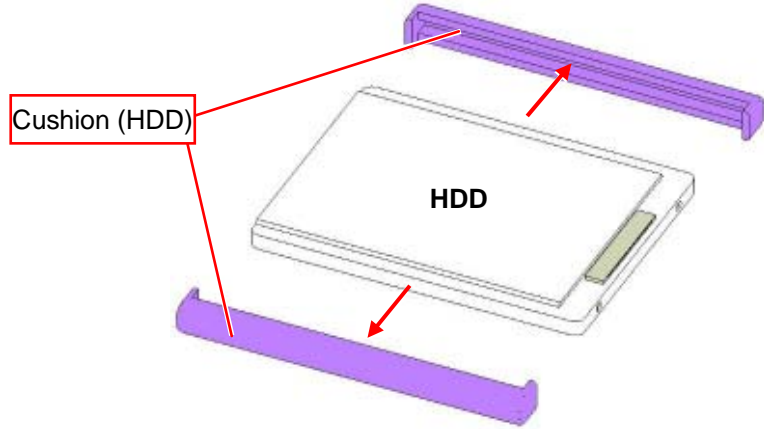

Remove the Cushion (two places).

SSD

Flash Memory Model

⚠ [MA]

1)

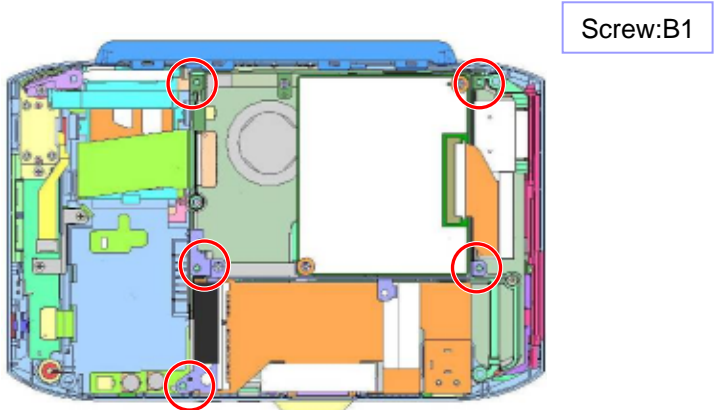

Remove the five screws.

2)

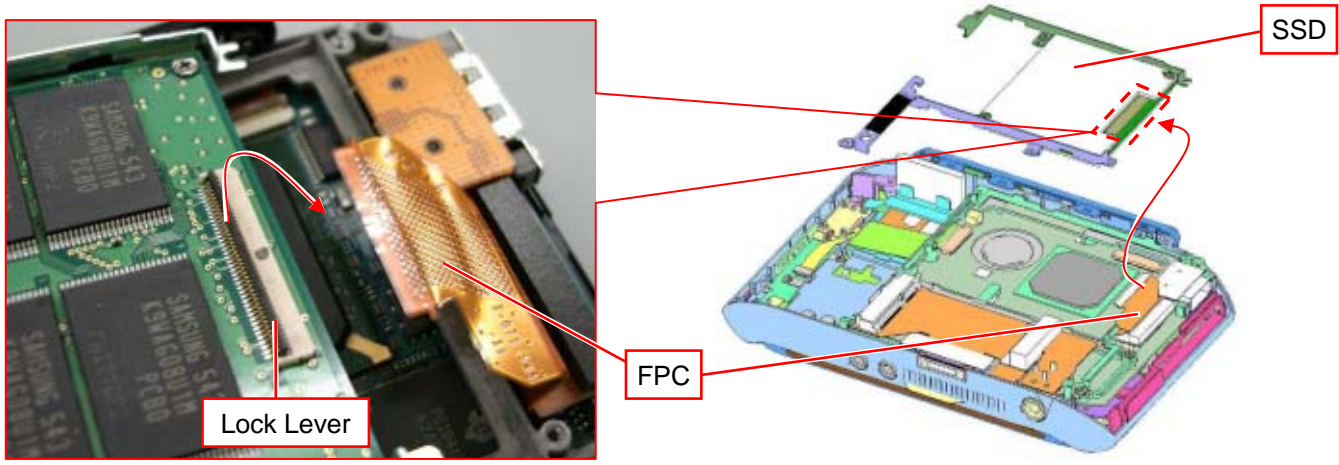

1. Raise the lock lever to release the lock.
2. While removing the FPC, remove the SSD.

Parts of the SSD

Flash Memory Model ⚠ [MA]

1)

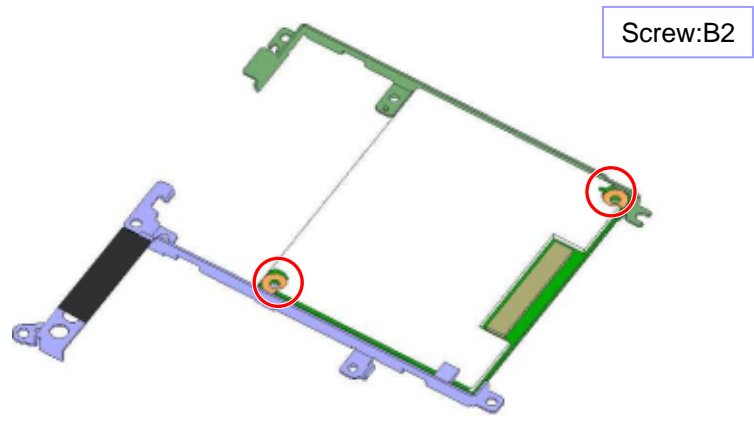

Remove the two screws.

2)

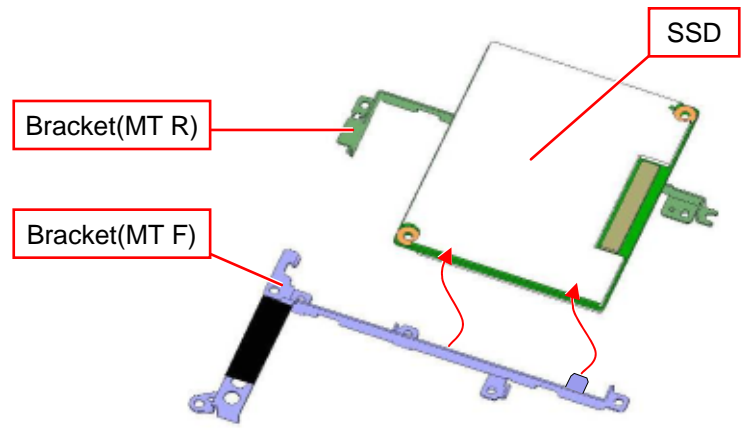

Remove the SSD.

Lithium Battery, Bracket (MS), Cover (WLB)

1)

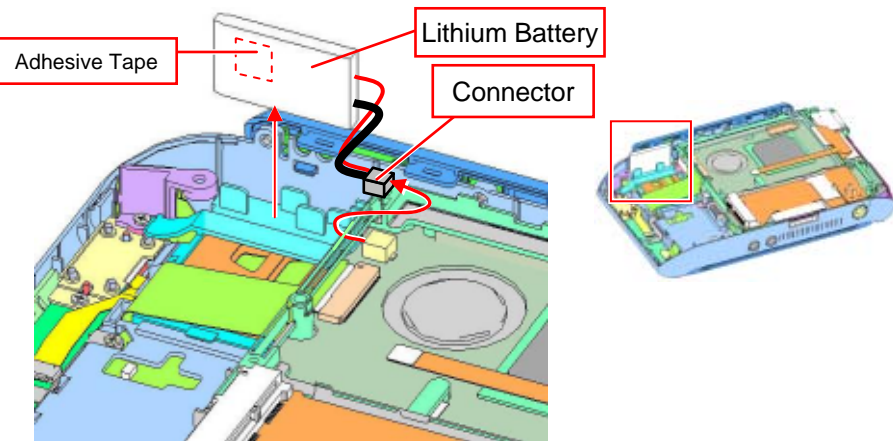

Disconnect the connector and remove the Lithium Battery.

* The Lithium Battery is secured with adhesive tape.

2)

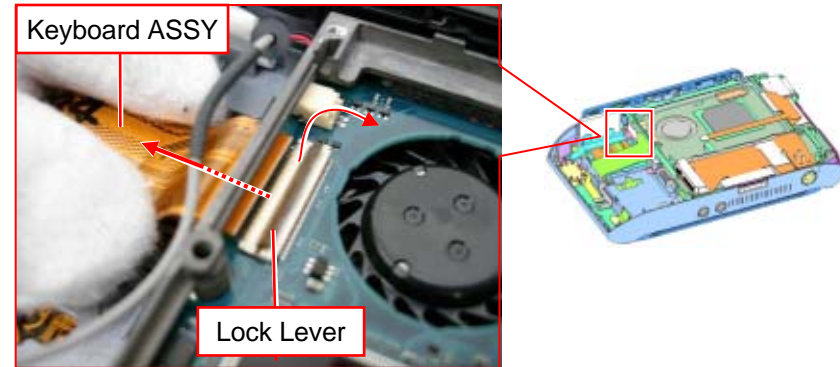

Raise the lock lever to release the lock and remove the Keyboard ASSY.

3)

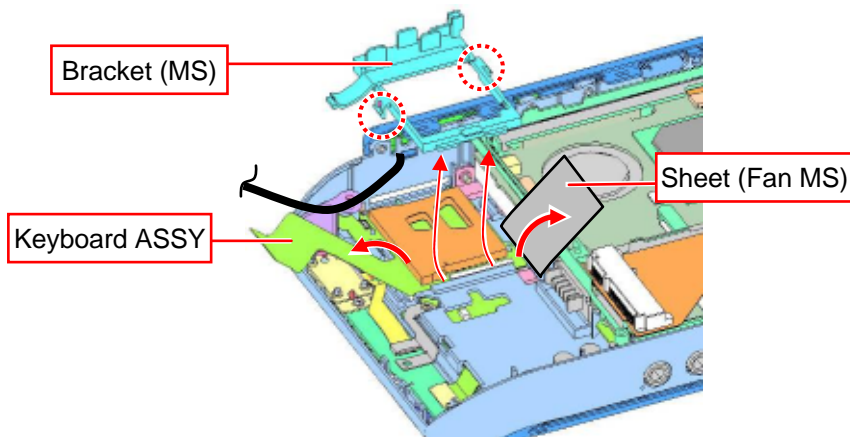

1. Turn over the Keyboard ASSY and the Sheet (one place).

2. Disengage the detent (two places) and remove the Bracket.

4)

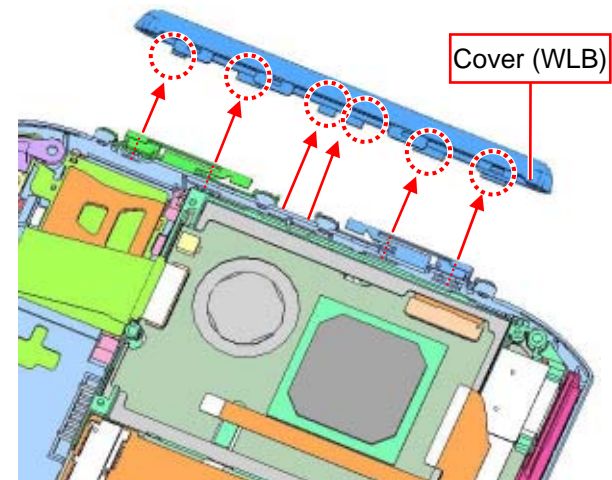

Disengage the detent (six places) and remove the Cover.

Mother Board

1)

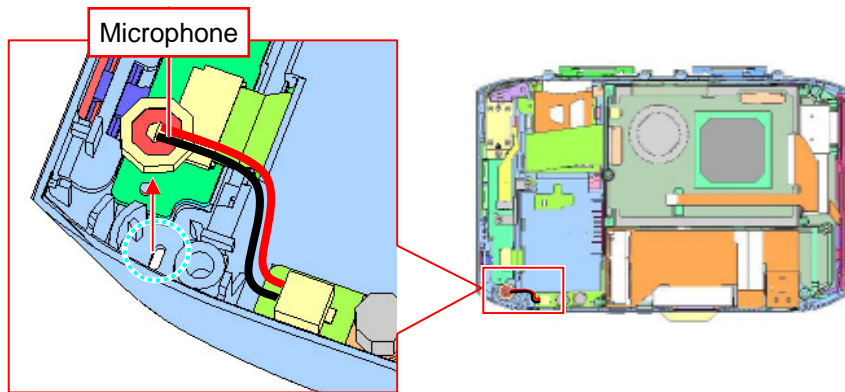

2)

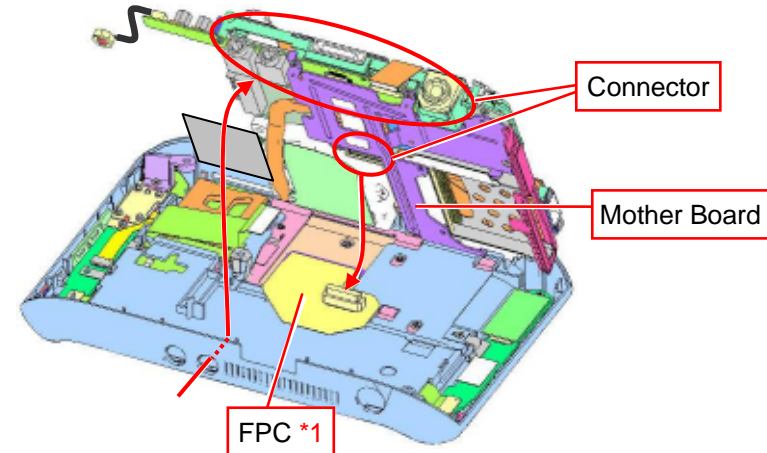

*1: The FPC is connected to the Mother Board.

Palmrest, LCD Section

1)

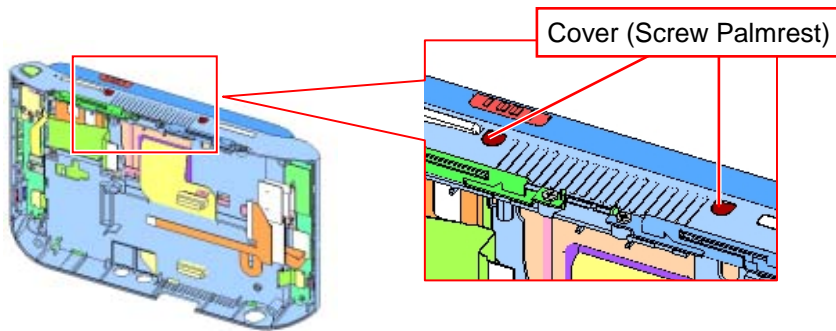

Peel off the Cover (two places).

2)

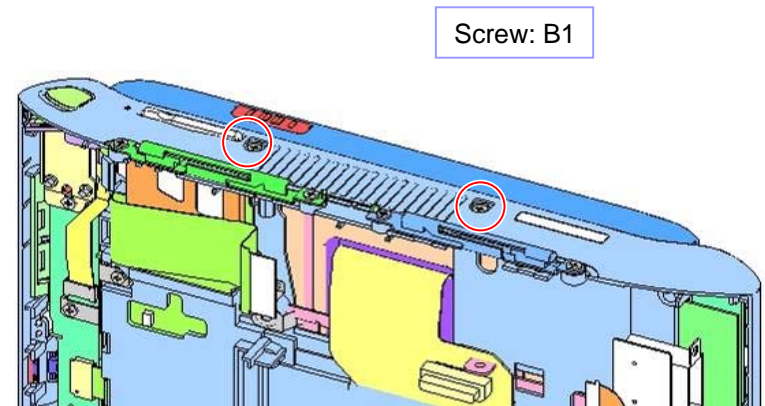

Remove the two screws.

3)

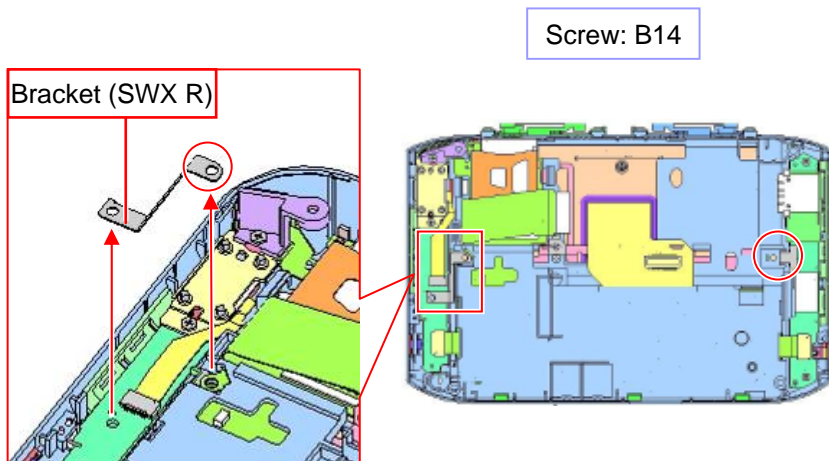

Remove the two screws and the Bracket.

4)

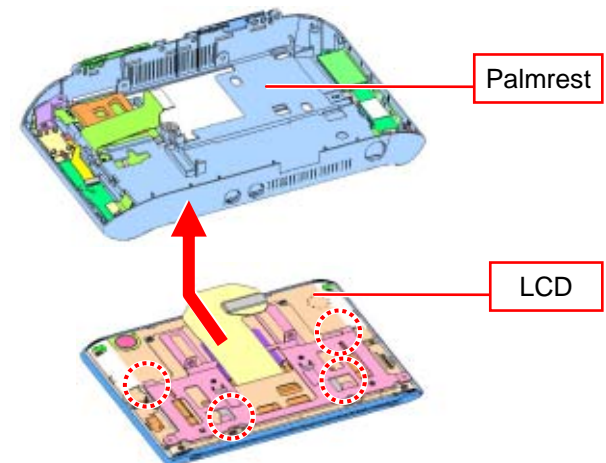

While disengaging the detent (four places), remove the Palmrest.

Update History

[ADD]---Addition [DEL]---Deletion [CHG]---Change [COR]---Correction [MA]---Model Addition

Date		Contents	Version No.
2006.06.08	①	[ADD] Procedure (Page 5)	1.10
2006.06.27	②	[MA] (Page 1) [COR] Description (Page 7)	1.20
2006.07.05	③	[MA] (Page 3, 3(a), 6, 8, 9, 9(a), 9(b))	1.30
2006.09.04	④	[ADD] Procedure (Page 6)	1.40